

WARING

MX1000TX

Hi-Power Blender with 64 oz. BPA-Free Copolyester Container



MAIN FEATURES

- Heavy-duty, high-performance 3½ peak HP motor with 2 speed selections is the strongest in its class. It powers through the toughest ice and frozen fruit mixtures in seconds.
- Super-high 30,000 RPM motor speed for the smoothest consistencies.
- Simple HI, LO, OFF, and PULSE paddle switches are easy to use and easy to find in dimly lit locations.
- The Raptor® 64 oz. stackable BPA-free copolyester container.
 - Ultra-aggressive blade and jar design delivers smoother consistencies and faster results
 - Unbreakable, dishwasher-safe construction
- High-grade, high-impact stainless steel blade is user replaceable for easy servicing.
- User-replaceable, metal-on-metal stainless steel coupling system for durability and reliability.
- Optional sound enclosure easily retrofits to base for noise reduction.
- One-piece, dishwasher-safe, removable jar pad
- Recommended for 75+ cycles per day
- Limited Three-Year Motor and Two-Year Parts & Labor Warranty.

ELECTRICAL

Voltage: 120V

Frequency: 60Hz

Watts: 1560W

Amps: 12.5A

Plug Type: NEMA 5-15P

Cord Length: 6 feet



SALES FEATURES

Get smooth, consistent results every time with the Waring® MX1000TX. This heavy-duty, powerful 3½ peak HP blender teams up with The Raptor® jar/blade assembly for maximum power and efficiency. It's ferocious enough for everything from smoothies and frozen drinks to thick spreads, desserts, dressings, and all types of food preparation. Clearly marked paddle switches control HI, LOW, OFF and PULSE features. Blend 75+ cycles per day. It's perfect for a busy bar, health facility, school, or coffee shop.























Hi-Power Blender with 64 oz. BPA-Free Copolyester Container

MX1000TX



Hi-Power Blender with 64 oz. BPA-Free Copolyester Container MX1000TX

PARTS & ACCESSORIES

- | | | | |
|---|--|---|--|
|  | CAC90
64 oz. Stainless Steel Container |  | CAC95-12
64 oz. Green Copolyester Container |
|  | CAC93X
48 oz. Copolyester Container |  | CAC95-28
64 oz. Orange Copolyester Container |
|  | CAC93X-03
48 oz. Yellow Copolyester Container |  | CAC116
Blending Assembly Kit and Retainer Ring Kit |
|  | CAC93X-06
48 oz. Blue Copolyester Container |  | CAC119
Retainer Ring Wrench |
|  | CAC93X-10
48 oz. Purple Copolyester Container |  | CAC158
Blending Assembly Kit |
|  | CAC93X-12
48 oz. Green Copolyester Container |  | CAC159
Retainer Ring Kit |
|  | CAC93X-28
48 oz. Orange Copolyester Container |  | CAC182
Drive Coupling |
|  | CAC95
The Raptor™ Aggressive, All-Purpose, Stackable 64 oz. BPA-Free Copolyester Container |  | CAC183
Drive Coupling |
|  | CAC95-03
64 oz. Yellow Copolyester Container |  | CAC161
Drive Coupling Removal Tool |
|  | CAC95-06
64 oz. Blue Copolyester Container |  | CAC169
Spatula – Custom designed for use with MX Series Blenders |
|  | CAC95-10
64 oz. Purple Copolyester Container |  | SE1500
Sound Enclosure |

DIMENSIONS

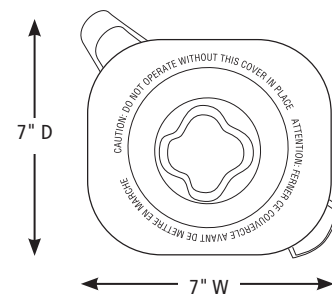
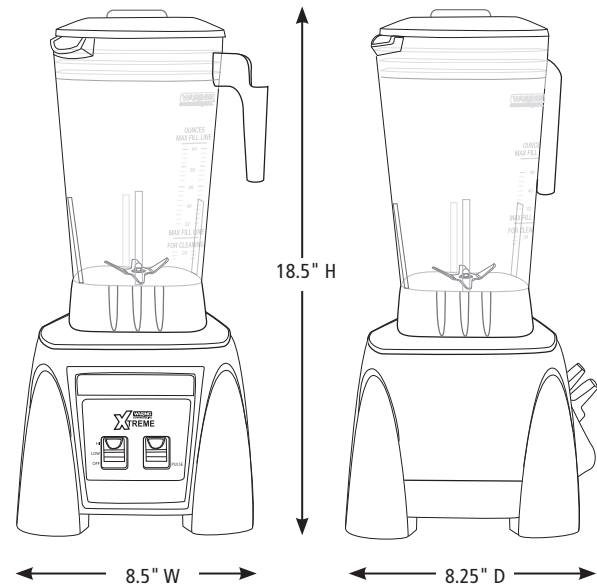

Out-of-Box Weight: 14.6 lb.

ORDERING INFORMATION	#STD. PKG.	GIFTBOX WEIGHT	CUBIC FEET	BOX DIMENSIONS D X W X H	UPC	CASE PKG.	MC WEIGHT	MC DIMENSIONS D X W X H	MBC
MX1000TX– Hi-Power Blender with 64 oz. BPA-Free Copolyester Container	1	16.75 lb.	1.033	11.375" x 10.125" x 15.5"	040072016998	1	17.7 lb.	11.75" x 10.75" x 16.125"	10040072016995



WolfLabs

Pricing on any accessories shown can be found by keying the part number into the search box on our website.

The specifications listed in this brochure are subject to change by the manufacturer and therefore cannot be guaranteed to be correct. If there are aspects of the specification that must be guaranteed, please provide these to our sales team so that details can be confirmed.

www.wolflabs.co.uk

Tel : 01759 301142

Fax : 01759 301143

sales@wolflabs.co.uk

Please contact us if this literature doesn't answer all your questions.